

# NOOSA

www.eosbathware.com.au

## 590MM WALL HUNG VANITY



- NOOS60MW
- 590x450x550mm
- Matte White
- Plywood
- Open back
- Waste cut-out top and bottom drawers
- 7-year residential warranty

- Product should be inspected prior to installation for surface damages.
- Clean with soapy water or a mild detergent and a soft cloth and rinse with warm water.
- All plumbing fitting should be installed by a qualified plumber in accordance with state laws.

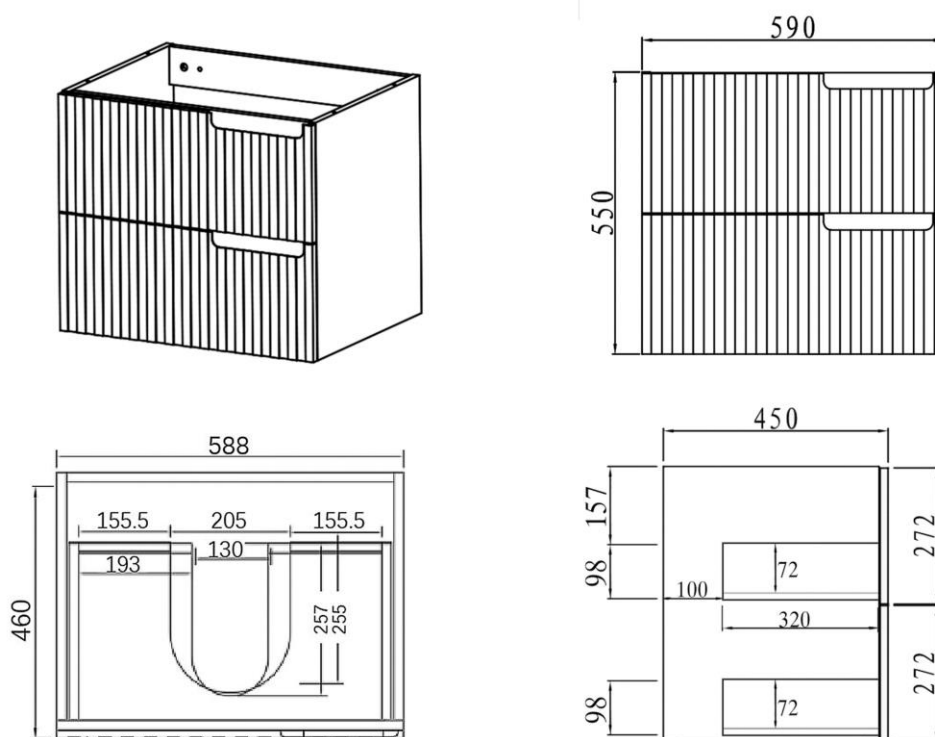

### Please note:

Dimensions are approximate. Information provided in this installation guide is representative of the actual product available at the time of printing. Due to our policy of continuous product development the design and specifications depicted are subject to change without notice. Please confirm all particulars with your sales consultant prior to purchase.

# NOOSA

www.eosbathware.com.au

## 740MM WALL HUNG VANITY



- NOOS75MW
- 740x450x550mm
- Matte White
- Plywood
- Open back
- Waste cut-out top and bottom drawers
- 7-year residential warranty

- Product should be inspected prior to installation for surface damages.
- Clean with soapy water or a mild detergent and a soft cloth and rinse with warm water.
- All plumbing fitting should be installed by a qualified plumber in accordance with state laws.

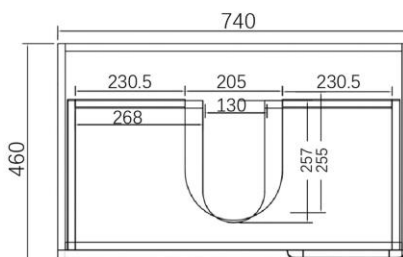
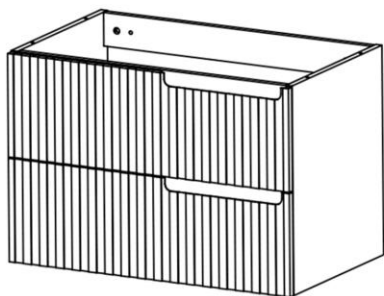
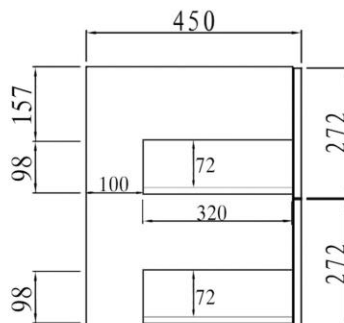
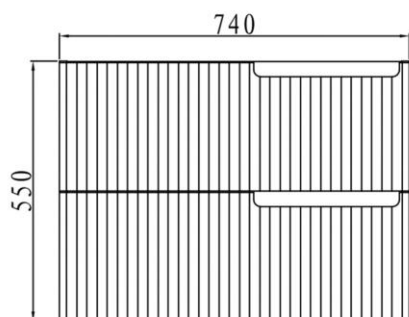

### Please note:

Dimensions are approximate. Information provided in this installation guide is representative of the actual product available at the time of printing. Due to our policy of continuous product development the design and specifications depicted are subject to change without notice. Please confirm all particulars with your sales consultant prior to purchase.

# NOOSA

www.eosbathware.com.au

## 890MM WALL HUNG VANITY



- NOOS90MW
- 890x450x550mm
- Matte White
- Plywood
- Open back
- Waste cut-out top and bottom drawers
- 7-year residential warranty

- Product should be inspected prior to installation for surface damages.
- Clean with soapy water or a mild detergent and a soft cloth and rinse with warm water.
- All plumbing fitting should be installed by a qualified plumber in accordance with state laws.

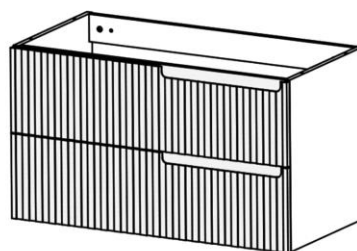
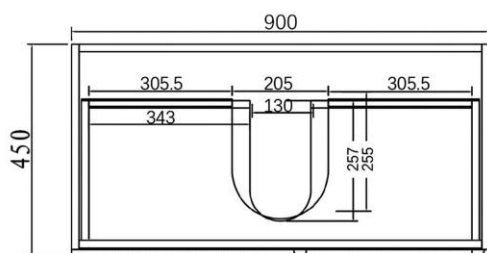
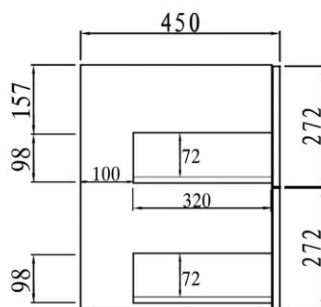
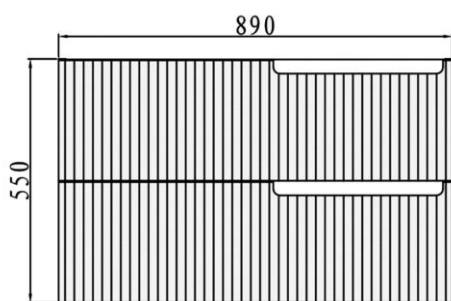

### Please note:

Dimensions are approximate. Information provided in this installation guide is representative of the actual product available at the time of printing. Due to our policy of continuous product development the design and specifications depicted are subject to change without notice. Please confirm all particulars with your sales consultant prior to purchase.

# NOOSA

www.eosbathware.com.au

## 1190MM WALL HUNG VANITY



- NOOS12MW
- 1190x450x550mm
- Matte White
- Plywood
- Open back
- Waste cut-out top and bottom drawers
- 7-year residential warranty

- Product should be inspected prior to installation for surface damages.
- Clean with soapy water or a mild detergent and a soft cloth and rinse with warm water.
- All plumbing fitting should be installed by a qualified plumber in accordance with state laws.

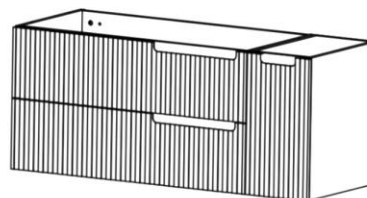
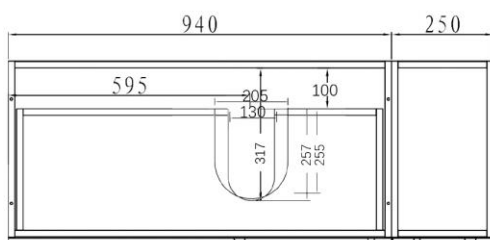
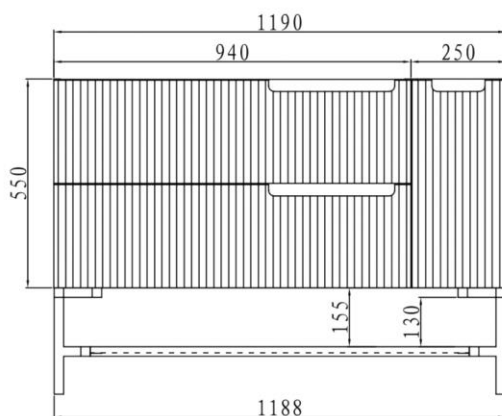

### Please note:

Dimensions are approximate. Information provided in this installation guide is representative of the actual product available at the time of printing. Due to our policy of continuous product development the design and specifications depicted are subject to change without notice. Please confirm all particulars with your sales consultant prior to purchase.

# NOOSA

www.eosbathware.com.au

## 1490MM WALL HUNG VANITY



- NOOS15MW
- 1490x450x550mm
- Matte White
- Plywood
- Open back
- Waste cut-out top and bottom drawers
- 7-year residential warranty

- Product should be inspected prior to installation for surface damages.
- Clean with soapy water or a mild detergent and a soft cloth and rinse with warm water.
- All plumbing fitting should be installed by a qualified plumber in accordance with state laws.

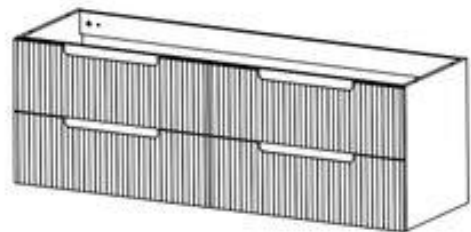
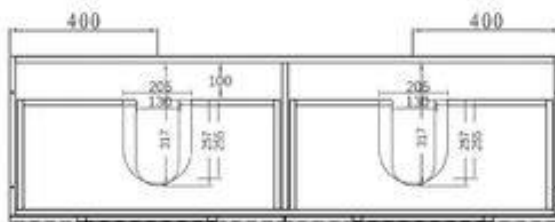
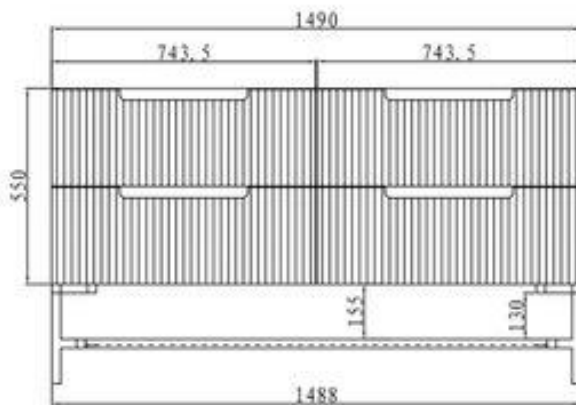

### Please note:

Dimensions are approximate. Information provided in this installation guide is representative of the actual product available at the time of printing. Due to our policy of continuous product development the design and specifications depicted are subject to change without notice. Please confirm all particulars with your sales consultant prior to purchase.